



TXMAS CONTRACT # 10-72010

LIGHT CORPORATION

Light

enlightening  
the workspace®

UNDER SHELF LIGHTING  
PERSONAL TASK LIGHTING

Prices shown herein are net

Price List effective: October 13, 2009 thru September 30, 2013

Light Corporation  
14800 172nd Avenue  
Grand Haven, MI 49417-8969

800-544-4899 toll free  
616-842-5100 phone  
616-846-2144 fax  
[www.lightcorp.com](http://www.lightcorp.com)

# What is “GREEN” lighting?

Lighting technologies that are focused on reducing energy and the negative effect on the environment.

**Light Corporation** is focused on utilizing the **latest technologies** to produce **energy saving, environmentally safe products.**

- Landfill acceptable lamps are standard for T5 and T8 products
- Electronic ballasts are standard in T5 & T8 products
- Increased efficiency products with options for high power factor electronic ballasts, dimming features and occupancy sensors
- Compact fluorescent technology in all personal desk lights
- LED Lighting solutions are on the horizon

Light’s on-going **ISO -14001 registration** ensures our manufacturing / disposal processes and company policies are **environmentally sound.**

- Our products are made with an eye toward recyclability
- We are engaged in on-going green programs to reduce materials.
- Manufactured products have high internal standards, our procedures are ISO 9001:2000 registered

**Light Corporation is proud to be:**

- A Michigan Clean Corporate Citizen
- A Member of the U.S. Green Building Council
- Part of the Michigan Business Pollution Prevention Partnership

**Making a responsible choice for lighting**

# Task light overview

The **Reed, SRD LED task light** is a low profile, LED linear solution for overhead bins and shelves. Reed can be used singly, connected together, or as a component with the entire Sprout® LED ecosystem. Reed utilizes energy-efficient LED technology. With multiple mounting options such as screw fastening for wood or magnetic fastening for metal shelves, consider Reed for all your application needs. See pages **15-16** for more information.



The **Wisteria, VT task light**, is designed to mount in most system shelving and overhead storage units. Its low-profile design allows for neat and inconspicuous installation beneath the overhead unit or shelf. The VT features a low mercury T8 tri-phosphor 3500K fluorescent lamp along with a high power factor electronic ballast and linear prismatic (batwing) lens. The VT is offered in 10 lengths. See pages **3-4** for more information.



The **Jasmine, UCT task light**, facilitates mounting in small, narrow applications. Transaction surfaces or reception areas often utilize this low-profile fixture. The UCT features a low mercury T8 tri-phosphor 3500K fluorescent lamp along with a high power factor electronic ballast and linear prismatic (batwing) lens. The UCT is offered in four lengths. See pages **5-6** for more information.

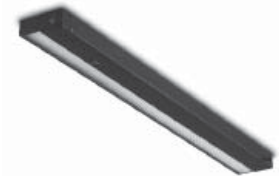

The **Baneberry, T5L task light**, with its low-profile radius design is compatible with nearly all open plan furniture systems. The T5L features a T5 3500K fluorescent lamp and a high power factor electronic ballast combined with a silver reflector and linear prismatic (batwing) lens for maximum reflectivity. The T5L is offered in four lengths. See pages **7-8** for more information.



# Personal task light overview

The **Trillium, TLED personal task light**, features a cool-running 3.7 watt solid state LED. LEDs are highly efficient (they produce low heat), rugged (no filament damage from shock or vibration), and long-lasting (up to 50,000 service hours). Equipped with a secondary optic that allows for the use of just one LED, the Trillium provides well-defined light patterns in a compact, cost-effective fixture. The trillium features a double-articulating arm with multiple mounting options. See pages **9-10** for more information.



The **Jumbo, JU personal task light**, is smart, sexy and remarkably efficient. Its 13 watt 3500K compact fluorescent lamp is 50% brighter than most; using a radiant mirror film reflector, it provides energy efficient illumination nearly as bright as an 18 watt lamp. This unique personal task light is available with a single arm and has five mounting choices, including Light's exclusive Railite™ mounting. See pages **11-12** for more information.



The **Huron, HU personal task light**, is a winning design ideal for compact work areas. The Huron combines cool-running, energy-savings light with the ultimate in versatile adjustability. Offered with two arm options and four mounting choices, including Light's exclusive Railite™ mounting, the Huron is a favorite for any office. This personal task light features an 18 watt 3500K compact fluorescent lamp and normal power factor electronic ballast. See pages **13-14** for more information.



# Wisteria

## VT task light

### VT base model includes:

- Energy efficient, low mercury T8 tri-phosphor 3500K fluorescent lamp
- High power factor electronic ballast
- 9° black power cord with 90° plug, sw rotation, right hand exit
- Black rocker switch, 2 position, right side of fixture
- Linear prismatic lens (batwing)
- UV stable silver reflector
- Mounting hardware package - must specify
- Paint finish - must specify
- UL, CUL, and CSA listed



Base Number	Suggested Shelf Size	Actual Length	Lamp Wattage
VT 18 ELE BW	24"	18.30"	15
VT 22 ELE BW	24"	21.87"	15
VT 24 ELE BW	30"-36"	24.30"	17
VT 28 ELE BW	30"	27.87"	17
VT 34 ELE BW	36"	33.87"	17
VT 36 ELE BW	42"-48"	36.30"	25
VT 40 ELE BW	42"	39.87"	25
VT 46 ELE BW	48"	45.87"	25
VT 48 ELE BW	54"-60"	48.30"	32
VT 58 ELE BW	60"	57.87"	32

The Wisteria, vt task light utilizes a high power factor electronic ballast and batwing lens. This task light is an energy efficient and glare resistant solution to your lighting needs.

Add the sensor or dimming options and watch your energy costs go down.

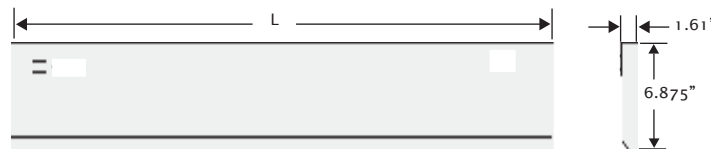

### Specifying notes:

- All VT fixtures include a high power factor electronic ballast.
- The center cord (CC) option is not available on the VT18, VT22 or VT24.
- The left hand (LH) cord option is not available on the VT18 or VT22.
- The field interchangeable cord (FIC) option is not available on the VT18 or VT22.
- When specifying the daisy chain (DC) option for the VT, specify one DCP (power cord fixture) and up to 9 DCJ (jumper cord fixture) - maximum total of 10 fixtures. See page 41 for more information.
- The power fixture in a daisy chain run can be specified as independent switching (DCP) or master control (MCDP).
- The DCP is available with a straight plug only.
- All daisy chain fixtures are only available with black cords.
- Cord managers are automatically included with daisy chain option.
- The daisy chain option is not available when specifying a Chicago cord.
- DIM3 and MDIM are not available on the VT18 or VT22.
- The occupancy sensor (OS) and dimming options cannot be combined on any size VT when using the daisy chain option.
- Mounting options include spring bars for metal shelf, tek screws for metal screw mount, or wood screws for wood or laminate shelves. See page 21 for manufacturer's cross reference codes.
- When specifying metallic colors on the VT, note that the end caps will be a non-metallic accent color.
- Cord covers are available in black (209), gray taupe (228), light tone (063), stone gray (062) and soft white (061); color code must be specified with size of cord cover.

# Wisteria

## VT task light

### VT base model prices

Base Number	Suggested Shelf Size	Actual Length	TXMASNet Price
VT 18 ELE BW	24"	18.30"	\$ 54.94
VT 22 ELE BW	24"	21.87"	57.62
VT 24 ELE BW	30"-36"	24.30"	57.96
VT 28 ELE BW	30"	27.87"	61.31
VT 34 ELE BW	36"	33.87"	62.31
VT 36 ELE BW	42"-48"	36.30"	62.65
VT 40 ELE BW	42"	39.87"	65.66
VT 46 ELE BW	48"	45.87"	67.34
VT 48 ELE BW	54"-60"	48.30"	68.01
VT 58 ELE BW	60"	57.87"	69.69

No minimum order quantity.

**Note:** Suggested shelf size is based on the length of the task light. For assistance in determining size of shelf and brackets needed, refer to page 23.

### Cord cover color code

Finish	Code
Black	209
Gray taupe	228
Light tone	063
Stone gray	062
Soft white	061

### VT option prices

Option	Description	Code	TXMAS Net Price
<b>Lamp:</b>	6500K	TRI65	\$ 5.08
	4100K	TRI41	0.00
	3000K	TRI30	0.00
<b>Cord exit:</b>	Left hand	LH	2.01
	Center	CC	2.01
	Field interchangeable	FIC	4.02
	Hardwire	HW	0.00
<b>Cord rotation:</b>	Straight plughead	SP	0.00
<b>Cord color:</b> <small>Available on straight cords only</small>	Gray	SPGR	2.68
	Neutral	SPNL	2.68
<b>Switch:</b>	Center	CS	2.01
<b>Interconnect:</b>	Power (Independent switching)	DCP	15.41
	<b>Daisy chain</b> <small>All cords on daisy chain fixtures are black</small>	MCDCP	15.41
	Jumper cord 42"	DCJ42	8.71
	Jumper cord 54"	DCJ54	8.71
	Jumper cord 78"	DCJ78	8.71
<b>Dimming:</b>	3 position stepped	DIM3	3.35
	Multi position stepped	MDIM	42.55
<b>Sensor:</b>	Occupancy sensor	OS	20.44
<b>City code:</b> <b>(Chicago)</b>	Fused plug -sw rotation	CHC9SW	16.08
	Fused plug -straight	CHC9ST	16.08
<b>Cord manager:</b>	Horizontal	CM1	1.01
	2- 2" vertical	CM2	1.01
	1 2" cord cover	CM3	.99
	Bag of 50 horizontal (CM1)	CM4	12.40
<b>Cord cover:</b>	24" cover (add color code)	CMC24	4.36
	48" cover (add color code)	CMC48	7.04

When choosing options refer to pages 15-19 to verify proper use.

### How to specify the VT task light

Example VT 36 LH OS 018 ST90

- base number
  - left hand cord exit
  - occupancy sensor
  - paint finish
  - mounting code
- 

- Specify base number for appropriate shelf size.
- Select option code from list.
- Select option code from list.
- Select paint finish from page 20.
- Select code for manufacturer and system name of unit that the light will be mounting in, page 21.

If manufacturer and system name code is not listed, identify them on your purchase order and a Light Corporation customer service rep will contact you on availability.

Call Light Corporation customer service to place an order, 1-800-544-4899.  
Prices are subject to change.

# Jasmine

## UCT task light

### UCT base model includes:

- Energy efficient, low mercury T8 tri-phosphor 3500K fluorescent lamp
- High power factor electronic ballast
- g' black power cord with 90° plug, sw rotation, right hand exit
- Black rocker switch, 2 position, right side of fixture
- Linear prismatic lens (batwing)
- UV stable silver reflector
- Mounting hardware package - screw mount only
- Paint finish - must specify
- UL, CUL, and CSA listed

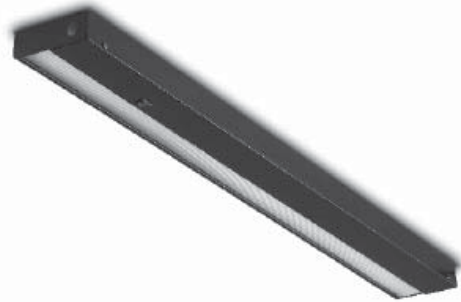

Base Number	Standard Suggested Shelf Size	Actual Length	Lamp Wattage
UCT 18 ELE BW	24"	18"	15
UCT 24 ELE BW	30"-36"	24"	17
UCT 36 ELE BW	42"-48"	36"	25
UCT 48 ELE BW	54"-60"	48"	32

Base Number	For Reuter overhead Suggested Shelf Size	Actual Length	Lamp Wattage
UCT KR 18 ELE BW	24"	18"	15
UCT KR 24 ELE BW	30"-36"	24"	17
UCT KR 36 ELE BW	42"-48"	36"	25
UCT KR 48 ELE BW	54"-60"	48"	32

The Jasmine, uct task light utilizes a high power factor electronic ballast and batwing lens. This task light is an energy efficient and glare resistant solution to your lighting needs. Add the sensor or dimming options and watch your energy costs go down.

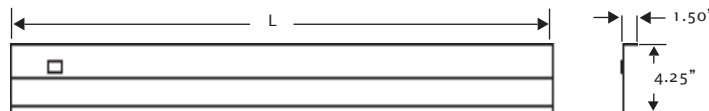

### Specifying notes:

- The standard cord exit location on the UCT is the right end of the light.
- DIM3 is not available on the UCT18.
- When specifying the daisy chain (DC) option for the UCT, specify one DCP (power cord fixture) and up to 9 DCJ (jumper cord fixtures) - maximum total of 10 fixtures. See page 41 for more information.
- The power fixture in a daisy chain run can be specified as independent switching (DCP) or master control (MCDP).
- The DCP is available with a straight plug only.
- All daisy chain fixtures are only available with black cords.
- Cord managers are automatically included with daisy chain option.
- The occupancy sensor (OS) and dimming options cannot be combined on any size UCT when using the daisy chain option.
- Keyhole slots in housing allow the UCT to be mounted to wood or laminate shelves only.
- Cord covers are available in black (209), gray taupe (228), light tone (063), stone gray (062) and soft white (061); color code must be specified with size of cord cover.

### Notes for UCT KR:

- The UCT KR can be mounted under a Reuter overhead and must be specified per chart above.
- The UCT KR is the Light Corporation equivalent to the Reuter task light.
- The daisy chain option is NOT available on the UCT KR.

# Jasmine

## UCT task light

### UCT base model prices

Base Number	Standard Suggested Shelf Size	Actual Length	TXMAS Net Price
UCT 18 ELE BW	24"	18"	\$ 63.99
UCT 24 ELE BW	30"-36"	24"	67.01
UCT 36 ELE BW	42"-48"	36"	69.35
UCT 48 ELE BW	54"-60"	48"	72.70

No minimum order quantity.

### For Reuter overhead

Base Number	Suggested Shelf Size	Actual Length	Net Price
UCT KR 18 ELE BW	24"	18"	\$ 67.01
UCT KR 24 ELE BW	30"-36"	24"	69.35
UCT KR 36 ELE BW	42"-48"	36"	71.70
UCT KR 48 ELE BW	54"-60"	48"	74.71

No minimum order quantity.

**Note:** Suggested shelf size is based on the length of the task light. For assistance in determining size of shelf and brackets needed, refer to page 23.

### Cord cover color code

Finish	Code
Black	209
Gray taupe	228
Light tone	063
Stone gray	062
Soft white	061

### UCT option prices

Option	Description	Code	TXMAS Net Price
<b>Lamp:</b>	4100K	TRI41	\$ 0.00
	3000K	TRI30	0.00
<b>Cord exit:</b>	Left hand	LH	2.01
	Center	CC	2.01
	Field interchangeable	FIC	4.02
	Hardwire	HW	0.00
<b>Cord rotation:</b>	Straight plughead	SP	0.00
<b>Cord color:</b> <small>Available on straight cords only</small>	Gray	SPGR	2.68
	Neutral	SPNL	2.68
<b>Interconnect:</b> <b>Daisy chain</b> <small>All cords on daisy chain fixtures are black</small>	Power (Independent switching)	DCP	15.41
	Power (Master control)	MCDPC	15.41
	Jumper cord 42"	DCJ42	8.71
	Jumper cord 54"	DCJ54	8.71
	Jumper cord 78"	DCJ78	8.71
<b>Dimming:</b>	3 position stepped	DIM3	3.35
<b>Sensor:</b>	Occupancy sensor	OS	20.44
<b>City code:</b> <b>(Chicago)</b>	Fused plug -sw rotation	CHC9SW	16-08
	Fused plug -straight	CHC9ST	16.08
<b>Cord manager:</b>	Horizontal	CM1	1.01
	2- 2" vertical	CM2	1.01
	12" cord cover	CM3	1.01
	Bag of 50 horizontal (CM1)	CM4	12.21
<b>Cord cover:</b>	24" cover (add color code)	CMC24	4.36
	48" cover (add color code)	CMC48	7.04

When choosing options refer to pages 15-19 to verify proper use.

### How to specify the UCT task light

Example UCT 24 LH OS 018

- base number
  - Left hand cord exit
  - Occupancy sensor
  - paint finish
- 

- Specify base number for appropriate shelf size.
- Select option code from list.
- Select option code from list.
- Select paint finish from page 20.
- Mounting hardware is supplied.

Call Light Corporation customer service to place an order, 1-800-544-4899.  
Prices are subject to change.

# Baneberry

## T5L task light

### T5L base model includes:

---

- Energy efficient T5 3500K fluorescent lamp
- High power factor electronic ballast
- 9' black power cord with 90° plug, sw rotation, right hand exit
- Black rocker switch, 2 position, right side of fixture
- Linear prismatic lens (batwing) with white overlay
- UV stable silver reflector
- Mounting hardware package - must specify
- Paint finish - must specify
- UL and CUL listed



Base Number	Suggested Shelf Size	Actual Length	Lamp Wattage
T5L 24 BW WO	<b>30"-42"</b>	22.72"	14
T5L 36 BW WO	<b>42"-48"</b>	34.53"	21
T5L 48 BW WO	<b>48"-60"</b>	46.34"	28
T5L 60 BW WO	<b>60"-72"</b>	58.16"	35

The Baneberry, T5L task light utilizes a T5 fluorescent lamp, high power factor electronic ballast and batwing lens. This low-profile task light is an energy efficient and glare resistant solution to your lighting needs.

Add the sensor option and watch your energy costs go down.



### Specifying notes:

---

- The center (CC) cord exit is not available on the T5L 24.
- When specifying the daisy chain (DC) option for the T5L, specify one DCP (power cord fixture), up to 6 DCJ (jumper cord fixture), and one DCE (end fixture) - maximum total of 8 fixtures. See page 41 for more information.
- The power fixture in a daisy chain run can be specified as independent switching (DCP) or master control (MCDCP).
- For all daisy chain fixtures (DCP, DCJ, and DCE) the cord location must be specified. Example: DCPR (right hand power cord), DCJR (right hand jumper) and DCER (right hand end unit).
- The DCP is available with a 90°, sw rotation fused plug only.
- All daisy chain fixtures are only available with black cords.
- The DCE has one 24" jumper cord with male plug to complete the daisy chain run.
- Maximum distance between 2 T5L daisy chain fixtures is 20".
- The FIC (field interchangeable option) is not available on daisy chain fixtures.
- Mounting options include spring bars for metal shelf, tek screws for metal screw mount, or wood screws for wood or laminate shelves. See page 21 for manufacturer's cross reference codes.
- Cord covers are available in black (209), gray taupe (228), light tone (063), stone gray (062) and soft white (061); color code must be specified with size of cord cover.

# Baneberry

## T5L task light

### T5L base model prices

Base Number	Suggested Shelf Size	Actual Length	TXMAS Net Price
T5L 24 BW WO	30"-42"	22.72"	\$ 68.68
T5L 36 BW WO	42"-48"	34.53"	75.38
T5L 48 BW WO	48"-60"	46.34"	82.08
T5L 60 BW WO	60"-72"	58.16"	92.13

No minimum order quantity.

**Note:** Suggested shelf size is based on the length of the task light. For assistance in determining size of shelf and brackets needed, refer to page 23.

### Cord cover color code

Finish	Code
Black	209
Gray taupe	228
Light tone	063
Stone gray	062
Soft white	061

### T5L option prices

Option	Description	Code	TXMAS Net Price
<b>Lamp:</b>	4100K	TRI41	\$ 0.00
<b>Cord exit:</b>	Left hand	LH	2.01
	Center	CC	2.01
	Field interchangeable	FIC	4.02
	Hardwire	HW	0.00
<b>Cord rotation:</b>	Straight plughead	SP	0.00
<b>Cord color:</b>	Gray	SPGR	2.68
	Neutral	SPNL	2.68
<b>Interconnect:</b>	Power-right hand exit <small>independent switching</small>	DCPR	15.41
<b>Daisy chain</b>	Power-left hand exit <small>independent switching</small>	DCPL	15.41
	Power-right hand exit <small>Master Control</small>	MCDCPR	15.41
	Power-left hand exit <small>Master Control</small>	MCDCPL	15.41
	Jumper fixture-right hand exit	DCJR	8.71
	Jumper fixture-left hand exit	DCJL	8.71
	End fixture-right hand exit	DCER	8.71
	End fixture-left hand exit	DCEL	8.71
<b>Sensor:</b>	Occupancy sensor	OS	20.44
<b>City code:</b>	Fused plug -sw rotation	CHC9SW	16.08
<b>(Chicago)</b>	Fused plug -straight	CHC9ST	16.08
<b>Cord manager:</b>	Horizontal	CM1	1.01
	2- 2" vertical	CM2	1.01
	12" cord cover	CM3	1.01
	Bag of 50 horizontal (CM1)	CM4	12.41
<b>Cord cover:</b>	24" cover (add color code)	CMC24	4.36
	48" cover (add color code)	CMC48	7.04

When choosing options refer to pages 15-19 to verify proper use.

### How to specify the T5L task light

Example T5L 36 LH OS 018 KNDD

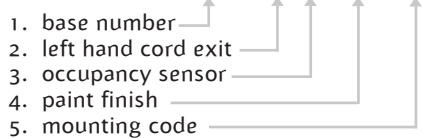

1. Specify base number for appropriate shelf size.
2. Select option code from list.
3. Select option code from list.
4. Select paint finish from page 20.
5. Select code for manufacturer and system name of unit that the light will be mounting in, page 21.

If manufacturer and system name code is not listed, identify them on your purchase order and a Light Corporation customer service rep will contact you on availability.

Call Light Corporation customer service to place an order, 1-800-544-4899.  
Prices are subject to change.

# Trillium

## TLED personal task light

### TLED personal desk light includes:

---

- 3.7 watt @700mA, single LED; 3500K
- 7' black cord with disconnect to power supply
- 120 VAC, 50/60 HZ input with 8' black cord with molded straight plug
- Black rocker switch, 2 position
- Parabolic lens
- Double-articulating arm
- Multiple mounting choices
- Finish - black
- UL and CUL listed



Base Number	Description
TLED	3.7 watt double-articulating arm

### Arm options:

---

**Double arm (D)** two straight arms, both arms move up and down. This option is ideal for large work spaces or offices where the mounting point is far from the task to be illuminated.

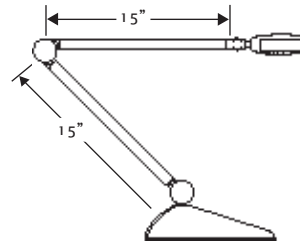

### Specifying notes:

---

- The power supply features an 8' cord with disconnect cord to fixture for easy installation. Allowing the user to install the light easily into new or existing installations.
- Total length, including the AC connection cord and fixture cord, is approximately 15'.
- The arm and head can be transferred from one base to another to accommodate reconfigured offices. Select the base / mounting application from the list on the next page.
- Panel mount design varies slightly with office furniture system panel.
- Cord managers available as an option for panel mount. See task light pages for cord manger information and pricing.
- The freestanding base has a footprint of 9" in diameter.
- Total weight of freestanding base is 9.3 pounds.

# Trillium

## TLED personal task light

### TLED base model prices

Base Number	TXMAS Net Price
-------------	-----------------

TLED	\$129.99
------	----------

No minimum order quantity.

### TLED option prices

Option	Description	Code	TXMAS Net Price
<b>Mounting:</b>	Freestanding	FS	\$ 39.20
	Clamp mount-min clearance	CMM	15.75
	Clamp mount-waterfall edge	CMW	19.10
	Panel mount	PM	14.07
	Surface mount	SM	12.06

### Mounting options:

**Freestanding (FS)** weighted base is supplied as the standard unless otherwise specified.

**Clamp mount minimum clearance (CMM)** allows the TLED to be mounted to most freestanding or hanging work surfaces. Adjusts to fit surfaces up to 2.25" thick. Two-piece design simplifies installation in an existing workstation.

**Clamp mount waterfall edge (CMW)** allows the TLED to be mounted to most freestanding or hanging work surfaces. Fit surfaces 1 1/8" to 1 1/2" thick.

**Panel mount (PM)** allows the TLED to be mounted to various office furniture system panels. System must be specified. See mounting cross reference page 22.

**Surface mount (SM)** allows the TLED to permanently attach to a work surface.

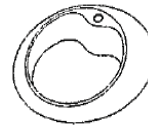

freestanding base



clamp mount - minimum clearance



clamp mount - waterfall edge



panel mount



surface mount

### How to specify the TLED personal task light

Example TLED CM

- base model
- mounting option

- Specify TLED.
- Select mounting option.

When PM is selected, select code for manufacturer and system name of unit that the light will be mounting in, page 22.

If manufacturer and system name code is not listed, identify them on your purchase order and a Light Corporation customer service rep will contact you on availability.

Call Light Corporation customer service to place an order, 1-800-544-4899.  
Prices are subject to change.

# J u m b o

## *JU personal task light*

### JU personal task light includes:

- 13 watt compact fluorescent 3500K lamp
- Normal power factor magnetic plug-in ballast
- 8' black cord with quick connect feature
- Silver toggle switch, 2 position
- UV stable silver symmetrical reflector
- Multiple mounting choices
- Finish - black or white
- CSA listed



Base Number	Description
JU S	13 watt single-articulating arm

### Arm options:

**Single arm (S)** straight arm that allows up and down movement of the arm. This option is ideal for small work spaces or offices where the mounting point is close to the task that needs to be illuminated.

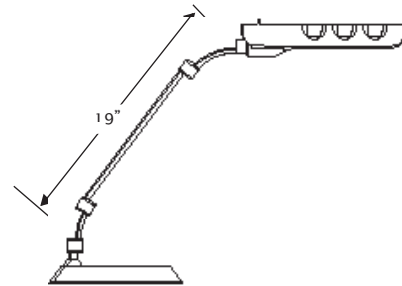

### Specifying notes:

- Detachable plug-in ballast, “quick connect”, allows the user to install the light easily into new or existing installations.
- The arm and head can be transferred from one base to another to accommodate reconfigured offices. Select the base / mounting application from the list on the next page.
- Panel mount design varies slightly with office furniture system panel.
- Chicago cord is applicable to the Railite mounting option only.
- Cord managers available as an option for railite, magnetic mount or panel mount options. See task light pages for cord manger information and pricing.
- The freestanding base has a footprint of 7” in diameter.
- Total weight of JU freestanding base is 3 pounds.

# Jumbo

## JU personal task light

### JU base model prices

Base Number	TXMAS Net Price
JU S	\$ 68.01

No minimum order quantity.

### Mounting options:

**Freestanding (FS)** weighted base is supplied as the standard unless otherwise specified.

**Clamp mount minimum clearance (CMM)** allows the JU to be mounted to most freestanding or hanging work surfaces. Adjusts to fit surfaces up to 2.25" thick. Two-piece design simplifies installation in an existing workstation.

**Clamp mount waterfall edge (CMW)** allows the JU to be mounted to most freestanding or hanging work surfaces. Fit surfaces 1 1/8" to 1 1/2" thick.

**Panel mount (PM)** allows the JU to be mounted to various office furniture system panels. System must be specified. See mounting cross reference page 22.

**Magnetic mounting (MM)** allows the JU to attach directly to the bottom of a metal shelf. A multi-pole ceramic magnet that is screwed to the light allows the JU to be mounted to metal surfaces.

**Railite™ mount (RL)** allows the JU to slide silently along a 31" rail mounted under a bin or shelf. The railite can be specified for mounting to wood shelves (WS) or metal shelves. For metal shelves, use manufacturer system code from page 21 (ref vt column).

**Surface mount (SF)** allows the JU to permanently attach to a work surface.

### How to specify the JU personal task light

Example JU S ES White

1. base model
2. arm option
3. mounting option
4. finish

### JU option prices

Option	Description	Code	TXMAS Net Price
<b>Mounting:</b>	Freestanding	FS	\$ 32.16
	Clamp mount-min clearance	CMM	15.75
	Clamp mount-waterfall edge	CMW	19.10
	Panel mount	PM	14.07
	Magnetic mount	MM	12.73
	Railite	RL	19.10
	Surface mount	SM	12.06

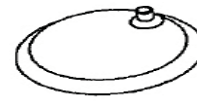

freestanding base



clamp mount - minimum clearance

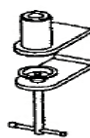

clamp mount - waterfall edge



panel mount



magnetic mount



railite™ mount



surface mount

1. Specify JU.
2. Select arm option.
3. Select base / mounting option.
4. Specify black or white.

When PM is selected, select code for manufacturer and system name of unit that the light will be mounting in, page 22. For RL option refer to VT column on page 21

If manufacturer and system name code is not listed, identify them on your purchase order and a Light Corporation customer service rep will contact you on availability.

Call Light Corporation customer service to place an order, 1-800-544-4899.  
Prices are subject to change.

# Huron

## HU personal task light

### HU personal task light includes:

- 18 watt compact fluorescent 3500K lamp
- Normal power factor in-line electronic ballast
- 11' black cord with molded straight plug
- Black rocker switch, 3 position - high/low/off
- UV stable silver symmetrical reflector
- Parabolic louver
- Multiple mounting choices
- Finish - black
- Head color - black or black with white edge accent
- CSA listed



Base Number	Description
HU S	18 watt single-articulating arm
HU D	18 watt double-articulating arm

### Arm options:

**Single arm (S)** straight arm that allows up and down movement of the arm. This option is ideal for small work spaces or offices where the mounting point is close to the task that needs to be illuminated.

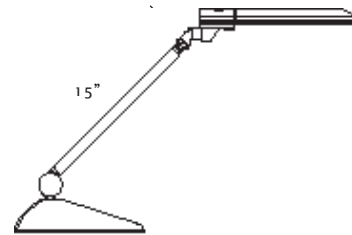

**Double arm (D)** two straight arms, both arms move up and down. This option is ideal for large work spaces or offices where the mounting point is far from the task to be illuminated.

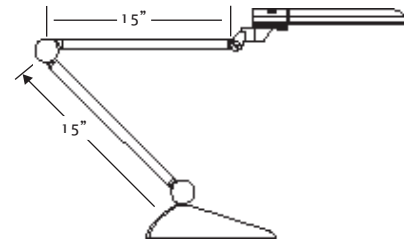

### Specifying notes:

- Detachable in-line ballast, “quick connect”, allows the user to install the light easily into new or existing installations.
- The arm and head of the single and double arm HU can be transferred from one base to another to accommodate reconfigured offices. Select the base / mounting application from the list on the next page.
- Panel mount design varies with office furniture system panel.
- Cord managers available as an option for railite or panel mount option. See task light pages for cord manger information and pricing.
- The railite mount option (RL) is only available for the single arm Huron (HU S).
- The freestanding base has a footprint of 9” in diameter.
- Total weight of the HU-S freestanding base is 5 pounds.
- Total weight of the HU-D freestanding base is 9.3 pounds.
- Code for head color must be specified on order:

Head accent color	Code
Black	BK
White	WH

# Huron

## HU personal task light

### HU base model prices

Base Number	TXMAS Net Price
HU S	\$ 101.85
HU D	116.59

No minimum order quantity.

### HU option prices

Option	Description	Code	TXMAS Net Price
<b>Mounting:</b>	Freestanding	FS	\$ 39.20
	Clamp mount-min clearance	CMM	15.75
	Clamp mount-waterfall edge	CMW	19.10
	Panel mount	PM	14.07
	Railite	RL	19.10
	Surface mount	SM	12.06

### Mounting options:

**Freestanding (FS)** weighted base is supplied as the standard unless otherwise specified.

**Clamp mount minimum clearance (CMM)** allows the HU to be mounted to most freestanding or hanging work surfaces. Adjusts to fit surfaces up to 2.25" thick. Two-piece design simplifies installation in an existing workstation.

**Clamp mount waterfall edge (CMW)** allows the HU to be mounted to most freestanding or hanging work surfaces. Fit surfaces 1 1/8" to 1 1/2" thick.

**Panel mount (PM)** allows the HU to be mounted to various office furniture system panels. System must be specified. See mounting cross reference page 22.

**Railite™ mount (RL)** allows the HU S to slide silently along a 31" rail mounted under a bin or shelf. The railite can be specified for mounting to wood shelves (WS) or metal shelves. For metal shelves, use manufacturer system code from page 21 (ref vt column).

**Surface mount (SF)** allows the TLED to permanently attach to a work surface.

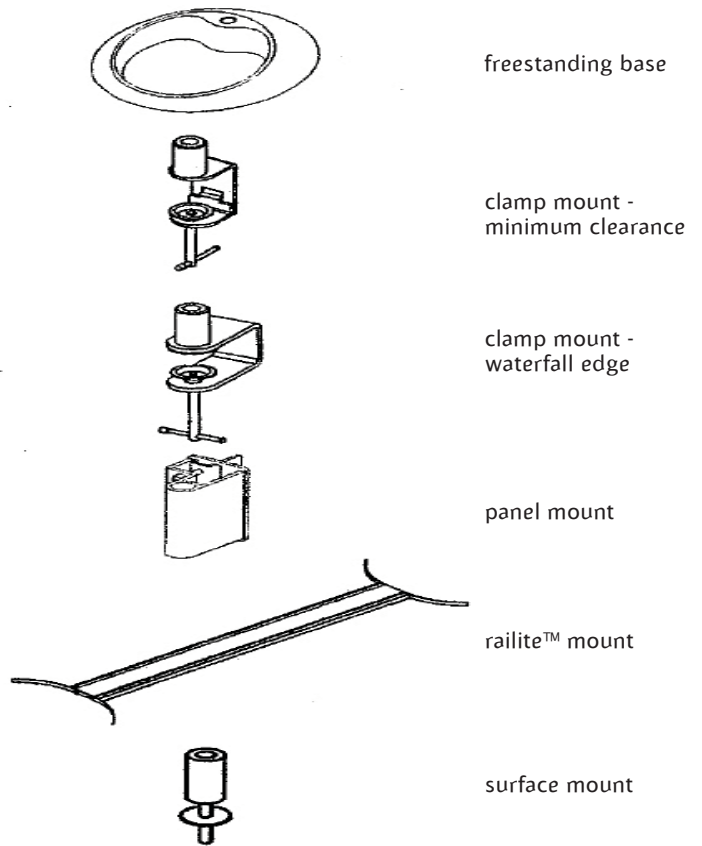

### How to specify the HU personal task light

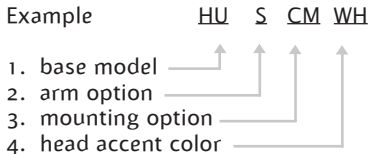

1. Specify HU.
2. Select arm option.
3. Select base / mounting option.
4. Select head color from previous page.

When PM is selected, select code for manufacturer and system name of unit that the light will be mounting in, page 22. For RL option refer to VT column on page 21.

If manufacturer and system name code is not listed, identify them on your purchase order and a Light Corporation customer service rep will contact you on availability.

Call Light Corporation customer service to place an order, 1-800-544-4899.  
Prices are subject to change.

# Reed

## SRD LED task light

### SRD model includes:

- 3 sets of 2 LEDs (10 watts)
- or 6 sets of 12 LEDs (20 watts)
- 60 W power supply with 12' black cord and molded straight plug
- 30" direct connect (DC) cord to connect fixture to power supply
- Switch - instant on; fade to off
- Variable Dimming is accomplished by holding in on/off switch
- Metal trough reflector with diffuser lens
- Clear anodized aluminium with flint color end-caps
- Magnetic or screw mount option
- Inter-connectable
- UL / CUL listed



### SRD list prices and component prices

Fixture	Mount Type	Suggested Shelf Size	Overall Length	Fixture Wattage	System Wattage	Description	TXMAS Net Price
<b>Base Model with Power Supply</b>							
SRD19 10w SPS60 MM CMAD CMPC	Magnet	24"-36"	19"	10	10.9	10 watt LED Light; 3 sets of 2 LEDs; 3500K; 60 watt PS; Adhesive Cord Mgr. & Vertical Clip	\$ 78.40
SRD19 10w SPS60 WS CMAD CMPC	Screws	24"-36"	19"	10	10.9	10 watt LED Light; 3 sets of 2 LEDs; 3500K; 60 watt PS; Adhesive Cord Mgr. & Vertical Clip	78.40
SRD37 20W SPS60 MM CMAD CMPC	Magnet	42"-72"	37"	20	21.9	20 watt LED Light; 6 sets of 2 LEDs; 3500K; 60 watt PS; Adhesive Cord Mgr. & Vertical Clip	117.56
SRD37 20W SPS60 WS CMAD CMPC	Screws	42"-72"	37"	20	21.9	20 watt LED Light; 6 sets of 2 LEDs; 3500K; 60 watt PS; Adhesive Cord Mgr. & Vertical Clip	117.56
<b>Inter-Connect Models (Adders no Power Supply)</b>							
SRD19 10w MM CMAD CMPC	Magnet	24"-36"	19"	10	10.9	10 watt LED Light; 3 sets of 2 LEDs; 3500K; Adhesive Cord Mgr. & Vertical Clip	55.61
SRD19 10w WS CMAD CMPC	Screws	24"-36"	19"	10	10.9	10 watt LED Light; 3 sets of 2 LEDs; 3500K; Adhesive Cord Mgr. & Vertical Clip	55.61
SRD37 20w MM CMAD CMPC	Magnet	42"-72"	37"	20	21.9	20 watt LED Light; 6 sets of 2 LEDs; 3500K; 60 watt PS; Adhesive Cord Mgr. & Vertical Clip	94.81
SRD37 20w WS CMAD CMPC	Screws	42"-72"	37"	20	21.9	20 watt LED Light; 6 sets of 2 LEDs; 3500K; Adhesive Cord Mgr. & Vertical Clip	94.81

### Options

Option	Description	Code	Net Price
<b>Interconnect:</b>	8" DC cord Reed to Reed	DCR8	\$2.68
	30" DC cord Reed to Reed	DCR30	2.68
	54" DC cord Reed to Reed	DCR54	4.02
<b>Cord Managers: (Set of 2)</b>	Cord Mgr: Horizontal - Magnetic	CMMM	2.68
	Cord Mgr: Horizontal - Plastic Adhesive Back	CMAD	1.01
	Vertical - Plastic Clip (set of 2)	CMPC	1.01
	Plastic End Cap	CMEC	1.01
	Inter-national	INTL	1.01

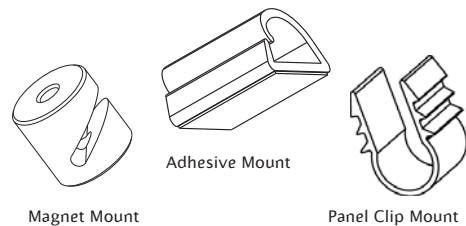

# Reed

## SRD LED task light

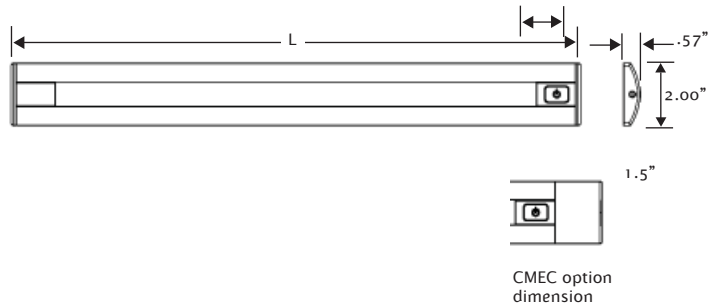

L = Actual Length - add CMEC  
\*System Wattage includes fixture and power supply

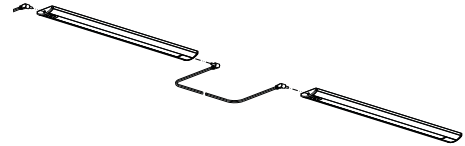

Inter Connect Option - Note for proper configuration, order first fixture with (60 w) power supply and not more that two additional fixtures without the power supply.

### Specifying notes:

- For interlinking 37 inch Reed, note sum of wattage.
- System accumulative wattage powered by one power supply must not exceed the power supply rated wattage.
- Direct connect (DC) cords are required to link Reed fixtures together, for each additional fixture one (1) DC cord is needed.
- Total length, including the AC connection cord and fixture cord, is 14 1/2'.
- The cord manager end cap is intened for case goods applications. This option extends the length of the fixture by 3" total (1.5" on each side). The DC cord is routed from the end cap up through a hole in the case goods shelf to completely conceal the cord.

# Option guide

Use this guide to help determine when to use each of the Light Corporation options

## Lamp options:

---

### Light Emitting Diode - LED lamps:

LEDs have the following advantages:

- Long life – up to 13 times longer than standard incandescent lamps - average life 50,000 hours per LED
- Size – typical package is only 2-5 mm in diameter
- Energy efficiency - LED fixture system including power supply offerings range from 3-30 watt usage
- Non-toxicity – contains no mercury or other hazardous materials, RoHS compliant
- Color options: 3500K is standard, while 4100K and others are available
- CRI > 75

### Fluorescent lamps:

Fluorescent lamps have the following advantages:

Efficient, fluorescent lamps can cost significantly less to operate over their lifetime than incandescent lamps. Life ratings range from 6000 to 24,000 hours based on the industry standard of burning 3 hours per start. Fluorescent lamps are available in a wide range of sizes, shapes, color performance, and wattage ratings.

**T8 tri-phosphor lamps:** Standard lamp in the VT and UCT task lights.

- The T8 tri-phosphor (1" diameter) lamp is up to 20% more efficient than the standard T8 or T12 lamps.
- Average life of 20,000 hours - means low lamp replacement and labor cost.
- Cooler operation - compared to halogen or incandescent lamps, reduces cooling costs.
- CRI (color rendering index) of 75.
- Color temperatures available: 3000K, 3500K and 4100K. 3500K is the Light Corporation standard. 3000K has a warmer look, similar to the warm white lamp. 4100K has a cooler look, similar to the cool white lamp.
- All T8 lamps are Ecologic lamps which have all the above standard features with the addition of a low mercury content.

**T5 fluorescent lamps:** Standard lamp in the MT5, A5L, T5L and IT task lights.

- The T5 (5/8" diameter) lamp has all of the advantages of the T8, but packs it into a more efficient package.
- Average life of 16,000 hours - means low lamp replacement and labor cost.
- Cooler operation - compared to halogen or incandescent lamps, reduces cooling costs.
- CRI (color rendering index) of 85 - most color accurate fluorescent source available.
- Color temperatures available: 3500K and 4100K. 3500K is the Light Corporation standard.
- The T5 utilizes an electronic ballast only.

**T5 high output fluorescent lamps:** Standard lamp in the AL5, AL16 and ITA ambient lights.

- Same features as the T5 lamps.
- Produces about 45% more initial lumens than the standard T5 lamp of the same size.

**T2 fluorescent lamps:** Standard lamp in the T2L task light.

- The T2 lamp is 1/4" diameter.
- Average life of 8,000 hours.
- CRI (color rendering index) of 80.
- Color temperatures available: 3500K and 4100K. 3500K is the Light Corporation standard.

### Compact fluorescent lamps:

Compact fluorescent lamps have the following advantages:

Energy cost savings of up to 75% vs. incandescent lamps of comparable light output.

Lamp life of up to 13 times longer than standard incandescent lamps.

High light output comparable, and in some cases exceeding, incandescent lamps.

**13 watt compact fluorescent lamps:** Standard lamp in the FT13 and JU personal task light, and the CSL task light.

- Average life of 10,000 hours.
- CRI (color rendering index) of 82.
- Available in 3500K.

**18 watt compact fluorescent lamps:** Standard lamp in the HU personal task light and optional in the CSL task light.

- Average life of 10,000 hours.
- CRI (color rendering index) of 80.
- Available in 3500K.

**20 watt compact fluorescent lamps:** Standard lamp in the FT20 personal task light.

- Average life of 6,000 hours.
- CRI (color rendering index) of 82.
- Available in 2700K.

# Option guide

Use this guide to help determine when to use each of the Light Corporation options

## Ballast options:

### Magnetic Ballast:

- Standard in the CSL task lights and the FT13 and JU personal task lights.
- A magnetic ballast uses a “core & coil” assembly to transform electrical current to start up and operate fluorescent lamps.

### Electronic Ballast:

- Standard in the MT5, VT, UCT, A5L, T5L, IT, and T2L task lights, the HU personal task light and all of the ambient lights.
- Optional for the CSL task lights.
- Operates at a cooler temperature (than magnetic) thus decreasing energy costs.
- Minimizes flickering caused by voltage fluctuations associated with copiers and laser printers.
- Eliminates interference with VDT through the omission of EMI (electro magnetic interference).
- Due to their solid state construction, they eliminate humming (audible noise) often associated with magnetic ballasts.

Normal power factor electronic ballasts are standard in all the linear task lights; for a more utility friendly lighting system, upgrade to a **high power factor / high performance electronic ballast**. High performance electronic ballasts have all the same features PLUS the current draw when using HPF is significantly lower, thus making it possible to put less lights on a circuit and reducing installation costs.

## Cord options:

- 9° black, 90° southwest (sw) plug rotation is the standard cord in the MT5, VT, UCT, A5L, T5L, IT, and T2L task lights, and the AL5 and ITA ambient lights.
- 9° black straight is the standard cord in the CSL task light and the AL16 ambient lights.
- 9° black straight is optional on the MT5, VT, UCT, A5L, T5L, IT and T2L task lights, and the AL5 and ITA ambient lights
- The FT13, JU, and HU personal task lights have a cord / ballast quick connect feature which allows the cord to be easily routed behind work surfaces.
- Cord colors are available on the straight cord only. Colors available: gray and neutral.
- Chicago Code cord is available in black only with a straight or sw plug rotation.



**Field Interchangeable Cord (FIC)** is a 9° cord with either a straight plug or 90° sw plug which allows the end user to change the cord location from a standard right hand exit to a left hand exit in the field.

- Specify when electrical configuration of office may vary, or outlet location has not been determined.
- This option is available in the VT, UCT, A5L, and T5L task lights only.
- This option is not available on the VT18, VT22 or UCT18 task lights.
- This option is not available on the MT5, IT, T2L and CSL task lights or the personal task and ambient lights.

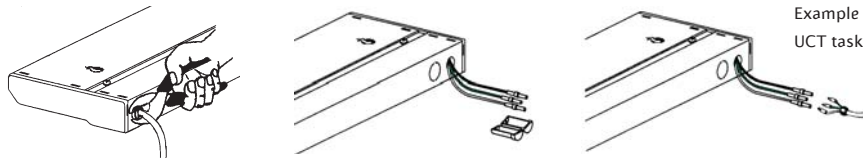

**Hardwire** option allows the user to wire the fixture to power source.

- This option is available in the MT5, VT, A5L, UCT and T5L task lights only.
- This option is not available on the IT, T2L and CSL task lights or the personal task and ambient lights.
- Wired for 120v 60hz. Pigtails are approximately 12” long.

### Cord managers:

- Available as options on all product lines.
- CM1 & CM4 kits are only available in white.
- CM2 & CM3 kits are only available in black.

**CM1:** Two horizontal cord managers- useful when managing cord behind the fixture.

**CM2:** Two 2” vertical cord managers- used to manage cord along vertical standard.

**CM3:** One 12” vertical- used to cover cord along vertical standard.

CM2 and CM3 fit most panel standards with 1” centers, call for availability.

**CM4:** Bag of 50 horizontal cord managers.

Others available for LED products, see page 7, and page 53.

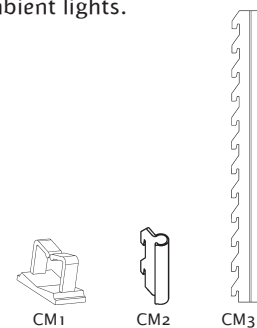

### Cord cover:

- Available as options on all product lines.
- Used to cover cord along a furniture panel.
- Cord cover kit consists of a 24” cover with 2 CM2 or 48” cover with 4 CM2.
- -fits most furniture panel standards with 1” centers, call for availability.
- Cord covers are available in black (209), gray taupe (228), light tone (063), stone gray (062) and soft white (061).

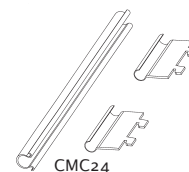

# Option guide

Use this guide to help determine when to use each of the Light Corporation options

## Cord options Daisy Chain:

**Daisy Chain** is the process of powering a fixture from the preceding fixture and reducing plug outlet use to one.

- This option is available on the VT, UCT and T5L task lights only.
- Maximum of 10 fixtures can be daisy chained together on the VT and UCT task lights.
- Maximum of 8 units can be daisy chained together on the T5L task lights.
- Cord managers are supplied with each daisy chain task light.
- The VT, UCT, and T5L daisy chain task lights are supplied with a CM1 kit (see previous page for drawing).
- This process is allowed in most cities (check your local code) but its application is carefully regulated due to the risk of overloading a circuit.
- Daisy chain cords are available in black only.

- **Independent Switching** - standard daisy chain configuration. With this option each fixture runs independently of the first fixture in the line and must be turned on or off individually.
- **Master Control** - optional daisy chain configuration and must be specified using MDCD. With this option, the first unit in the line controls the power of all down line fixtures. Each down line fixture can be switched independently once the power is supplied. Benefit of using the master control option is that all down line fixtures can be left on all the time, thus allowing the user to only have to switch on/off one fixture (the fixture with the power cord).

## VT and UCT task lights

### DCP & MDCD

- This is the first fixture in the line and is supplied with two business machine receptacles, one receptacle male and the other female and a 9' SJT, 16 gauge power cord with a straight plug and mating receptacles.
- The daisy chain option for the VT and UCT task lights is not available when specifying a Chicago cord.

### DCJ

- All down line fixtures in a daisy chain arrangement are referred to as "jumper" fixtures.
- This fixture is supplied with two business machine receptacles, one receptacle male and the other female and a jumper cord with mating receptacles.
- When ordering the "Jumper" fixture for the VT or UCT task light you must specify the length of jumper cord. This is determined by adding the length of the two task lights, plus the distance between the overhead units, divide that number by 2 and then add 6".
- Jumper cord lengths available: 42", 54" or 78"

### Example

When daisy chaining two 36" fixtures with a 12" space between the overheads, the formula would be:  
 $36 + 36 + 12 = 84 / 2 = 42 + 6 = 48"$ . You should request a 54" jumper cord.

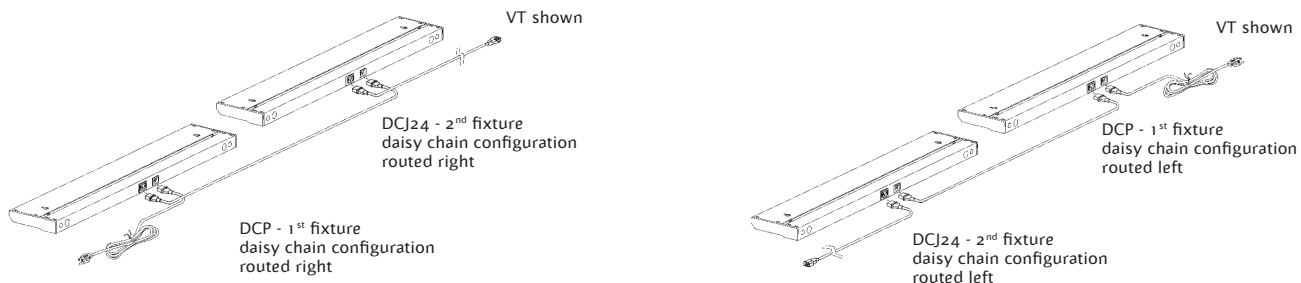

# Option guide

Use this guide to help determine when to use each of the Light Corporation options

## Cord options Daisy Chain:

---

### T5L task lights

#### DCP & MCDCP

- This is the first fixture in the line and is supplied with a 9' SJT, 18 gauge, 90° sw rotation fused plug power cord and a 7" jumper cord.
- The exit location (R or L) of the power cord must be specified using order code DCPR or DCPL (for master control MCDPR or MDCPL).

#### DCJ

- Fixtures connecting the power and last fixture in a daisy chain arrangement are referred to as "jumper" fixtures.
- This fixture is supplied with a 24" jumper with male plug and a 7" jumper cord with receptacle.
- The exit location (R or L) of the 24" jumper cord must be specified when ordering jumper fixtures using code DCJR or DCJL.
- If the exit location of the power cord was specified as right hand, then all jumper fixtures should be specified right handed as well (same rule for left hand run).
- Maximum distance between 2 T5L fixtures 20".

#### DCE

- This is the last fixture in a daisy chain arrangement and supplied with a 24" jumper cord with male plug only.
- The exit location (R or L) of the jumper cord must be specified when ordering the end unit using codes DCER or DCEL.
- If the exit location of the power cord and jumper fixtures were specified right hand, then the end fixture should be specified right hand as well (same rule for left hand exit run).

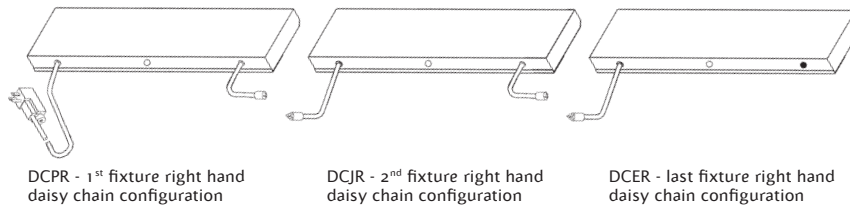

## Dimming options:

---

### DIM3: Tri Level Dimming

- Provides light output levels of 100%, 78%, and 53%.
- Controlled by a black rocker switch.
- Available as option on the VT and UCT task lights only.

### MDIM: Multi Level Dimming

- Provides light output levels from 100% on to 30% on in 6 discreet steps.
- Controlled by a black rocker switch.
- Available as an option on the VT task light only.

### Variable Dimming

- Provides light output levels of 100% to 15%
- Provides light output levels controlled by a momentary flint colored switch,
- Standard feature on the reed LED task light only.

## Lens options:

---

### Linear prismatic lens, also called batwing, (BW).

- An acrylic lens with a pattern that is made of two-sided prisms. The pattern is composed of ridges and valleys that run perpendicular to the user. When the light from the source passes through the pattern, it is directed perpendicular to the user. The purpose of directing the light perpendicular to the user is to reduce the amount of reflected light that bounces off the work surface, and back up into the eyes of the user.



# Option guide

Use this guide to help determine when to use each of the Light Corporation options

## Occupancy sensor option:

### Operation

Light Corporation's Occupancy Sensor (OS) uses a passive infrared (PIR) sensing technology that turns lights on and off based on movement /changes in infrared energy (moving body heat) within the coverage area. Once the coverage space is vacant and the time delay elapses (factory set at 30 minutes), the lights will turn off. This slim low profile sensor is mounted on the bottom rear of the fixture and uses an optical lens to monitor movement. Sensors must directly "see" motion of an occupant to detect them, so careful consideration must be given to sensor placement. Avoid placing the sensor where obstructions may block the sensor's line of sight.

### OS Benefits

- Reduces energy costs by turning lights off when not needed.
- Convenience for the user.

### Specification Guidelines

- Specify when energy cost reduction is a priority.
- The OS option automatically includes a high power factor electronic ballast.
- Available on the MT5 and UCT task lights only.

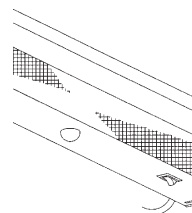

### User Guidelines

- Room temperature affects the operation. The sensor is constantly monitoring the area and updating the sensor with new data / "pictures". This minimizes the effect of room temperature changes and hot spots, such as windows. Sudden changes in temperature can cause the sensor to trigger.
- Occupant Motion – The sensor senses motion along the horizontal axis of the lens. Small motions that do not cross the axis will not be sensed and the unit will "time out".
- Ambient air movement – The PIR technology senses change in temperature. Under higher temperature operation (95°F) moving air can effect the operation.
- Field of view has a large impact on the sensor's ability to function properly. The occupancy sensor must be in range and view of the person to be detected. This typically works best on exposed areas of skin, as clothing can block thermal radiation from your body. Hands, arms, head and neck are the best radiators of this signal. The white dome on the sensor is designed to focus signals to the sensor. If the user can see the sensor well, and is in range of the sensor, then it is monitoring that person. Items in the workstation (i.e.chairs) can limit the field of view. Remember, more field of view means higher signal quality and reliability.
- **Important**, there is an initial warm-up period. It may take up to a minute before the lights turn on due to a sensor warm-up period required during initial power-up. This occurs during installation, after a lengthy power failure, or if the fixture has been switched off for a period of time.

### Troubleshooting

- Given the above considerations, the fixture with the sensor should be placed where it will function most effectively. It should be away from heating, ventilation & air conditioning vents and ducts.
- To prevent a passerby from triggering the fixture, it should be placed away from looking across entry ways, unless out of the sensor range.
- Obstacles should be eliminated so that motion can be sensed.
- The sensor recognizes movement that breaks the plane of it's vision, which is a cone shape area that starts at the sensors eye and projects downward at approximately a 45° angle.

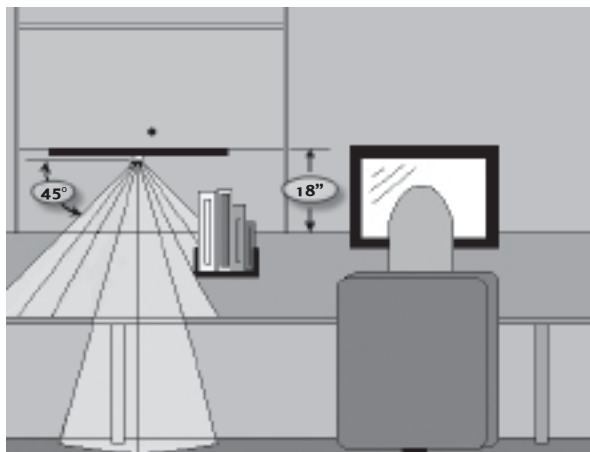

### Energy Savings and Cost Analysis Calculations - EXAMPLE

Cost per KWHf	\$0.08	Cost per week	\$1.15	Controlled hours per week	24
Task light watts	40	Cost per year	\$7.60	Controlled savings	50%
Hours per week	48	No. of offices (2 per office)	500	Savings per year	\$3,000.00
Typical cost per year	\$7,600.00				

### Savings per sensor per year \$3.80

Hours per week assumes typical work week.

# Paint finish guide

## Light Corporation standard colors for task and ambient lights

Neutral	Code	Gray	Code	Dark	Code	Metallic	Code
Light tone	063	Stone gray	062	Black	209	Champagne	138
Neutral	019	Gray taupe	228	Black - VT only	078	Charcoal	021
Sand	074	Innertone light	060	Charcoal	066	Dark champagne	136
Tan	067	Light gray	018	Dark gray	020	Dark silver	409
White	003	Medium gray	055	Medium tone	056	Pewter	011
		Pebble	065			Silver	058
		Silver star	077				

- Products ordered in Light Corporation standard colors have a two week lead time.
- Some colors may require additional lead time.
- When specifying metallic colors on the MT5, VT or T2L task light, note that the end caps will be a non-metallic accent color.

## Manufacturer cross-reference guide for task and ambient lights

Mfg.	Color	Code	Mfg.	Color	Code	Mfg.	Color	Code
Allsteel			Group LaCasse (Anderson Hickey)			Steelcase		
Black		209	Beige TR-R		108	Beach		228
Cloud		077	Charcoal TR-K		209	Black		209
Driftwood		156	Tan TR-T		113	Blush		065
Flint		158	Mercury TR-HA		018	Coffee		209
Parcment		159				Cream		065
Loft		294	Kimball			Dawn		060
Bungalow		295	Cinder		209	Driftwood		228
Brownstone		293	Clay		113	Graphite		057
Flex-Y-Plan			Driftwood		228	Gray value 1		077
Charcoal		066	Flint		057	Gray value 2		018
Natural almond		063	Graphite		020	Gray value 5		066
Pearl		061	Oyster		061	Greyslate		057
Slate		057	Sandstone		065	Khaki		228
Haworth			Seagull		074	Mist		018
Beige		108	Shale		060	Putty		019
Chalk		061	Storm		018	Shale		056
Charcoal		066	Knoll			Slate		057
Clay		060	Beige Mist Metallic 611		138	Smoke		018
Graphite		020	Brown 112		223	Tan value 1		019
Gray tone		228	Dark Grey 113		066	Vanadium		012
Neutral tone		019	Folkstone Grey 114		062	Warm brown value 1		065
Platinum		062	Jet Black 111		078	Warm brown value 2		113
Putty		077	Medium Grey 115		057	Warm white		061
Sand		065	Medium Metallic Grey 612		410	White		003
Smoke		018	Sandstone 116		104	Woodrose		060
Stone		228	Silver 613		058			
Tan		113	Soft Grey 117		077			
Herman Miller			Teknion					
Black Umber		209	Ebony		209			
Dark Tone		066	Granite		020			
Folkstone Grey		062	Gray		018			
Just Tan		067	Nevada		074			
Light Grey		055						
Light Tone		063						
Maple sugar		223						
Medium Tone		056						
Metallic Champagne		138						
Metallic Silver		058						
Neutral Light		019						
Sandstone		137						
Slate Grey		057						
Soft White		061						

- This list represents Light Corporation's **equivalent** to the system manufacturer's color.
- When specifying metallic colors on the MT5, VT or T2L task light, note that the end caps will be a non-metallic accent color.
- If a manufacturer color is not listed, contact Light Corporation customer service or your sales representative for availability and applicable set-up charges.
- This list is subject to change.

# Mounting cross reference

## For task lights / undershelf mounting

Manufacturer	System Name	Code	MT5	VT	A5L	T5L	T2L	SPR	
<b>AIS</b>	Matrix	AIMX	X	X	X	X	X	X	
<b>Allsteel</b>	8000	AL80	X	X	X	X	X	X	
	Concensys	ALCO	X	X	X	X	X	X	
	Essentials	ALES	X	X	X	X	X	X	
	Interchange	ALIG	X	X	X	X	X	X	
	Terrace	ALTE	X	X	X	X	X	X	
<b>Artopex</b>	Imagine	ARIM	X	X	X	X	X		
	TakeOff	ARTO	X	X	X	X	X		
<b>Design Options</b>	Design Options	DEOP	X	X	X	X	X		
<b>Global</b>	Evolve	GLEV*	X	X	X	X	X	X	
<b>Groupe LaCasse</b>	Avenue	LAAV	X	X	X	X	X	X	
	Nvision	AHNV	X	X	X	X	X	X	
<b>Haworth</b>	Castelli 3D	HWCT	X	X	X	X	X		
	Compose	HWCP	X	X	X	X	X		
	One Touch	HWOT*	X	X	X	X	X	X	
	Places STD	HWPL*	X	X	X	X	X	X	
	Places deep shelf	HWPD*	X	X	X	X	X	X	
	Premise / Compose	HWPM*	X	X	X	X	X	X	
	Race	HWRC	X	X	X	X	X	X	
	Tango	HWTO	X	X	X	X	X	X	
	Unigroup STD	HWUG	X	X	X	X	X	X	
	Unigroup deep shelf	HWUD	X	X	X	X	X	X	
<b>Herman Miller</b>	A-style flipper door	HMIA**	X	X	X	X	X	X	
	B-style flipper door	HMIB**	X	X	X	X	X	X	
	C-style flipper door	HMIC	X	X	X	X	X	X	
	E-style flipper door	HMIE	X	X	X	X	X	X	
	Passage	HMPS*	X	X	X	X	X	X	
	Q-System	SQAQ	X	X	X	X	X	X	
	5000	HM50	X	X	X	X	X	X	
	Vivo	HMVV	X	X	X	X	X	X	
<b>Hon</b>	3800	HN38	X	X	X	X	X	X	
	Initiate ***this is panel sys	HNIN	X	X	X	X	X		
	Simplicity II	HNSM	X	X	X	X	X	X	
<b>Inscape</b>	Platform Series	INPL	X	X	X	X	X		
<b>Invincible Furniture</b>	Vista 2000	IFV2	X	X	X	X	X	X	
<b>Kimball</b>	Cetra	KMCT	X	X	X	X	X	X	
	Footprint	KMEP	X	X	X	X	X	X	
	Interworks	HPIW*	X	X	X	X	X	X	
	Skate	KMSK	X	X	X	X	X	X	
	Xsite	KMXS	X	X	X	X	X	X	
<b>Knoll</b>	AutoStrada	KNAS	X	X	X	X	X	X	
	Calibre	KNCA	X	X	X	X	X		
	Equity	KNEQ	X	X	X	X	X		
	Dividends	KNDD	X	X	X	X	X		
	Morrison Network	KNMN	X	X	X	X	X		
	Morrison Options	KNOP*	X	X	X	X	X		
	Reff	KNRF	X	X	X	X	X	X	
	Reuters	KNRE*	see page 28-29 for information on the UCT KR task light						
	Series II	KNS2	X	X	X	X	X		
<b>KI</b>	System 3000	KR30	X	X	X	X	X	X	
	Balance	KIBL	X	X	X	X	X	X	
	Universal	KIUN	X	X	X	X	X	X	
	Wireworks	KIWW*	X	X	X	X	X	X	
<b>Pleion</b>	Curvilineal	PCCL	X	X	X	X	X	X	
<b>Steelcase</b>	9000 & Enhanced 9000	ST90*	X	X	X	X	X	X	
	Answer	STAN*	X	X	X	X	X	X	
	Avenir	STAV*	X	X	X	X	X	X	
	Benchmark	STBM*	X	X	X	X	X	X	
	Context	STCT*	X	X	X	X	X	X	
	Currency	STCY*	X	X	X	X	X	X	
	Elective Elements	STEE*	X	X	X	X	X	X	
	Elective Elements - wood	STEW*	X	X	X	X	X	X	
	Ellipse	STEL*	X	X	X	X	X	X	
	Kick	STKK*	X	X	X	X	X	X	
	Kick Freestanding	STKF*	X	X	X	X	X	X	

# Mounting cross reference

## For task lights / undershelf mounting - continued

Manufacturer	System Name	Code	MT5	VT	A5L	T5L	T2L	SPR
<b>Steelcase - cont</b>	Montage	STMT*	X	X	X	X	X	X
	Movable Wall & Valencia	STMW*	X	X	X	X	X	X
	Pathways / Secant	STPA*	X	X	X	X	X	X
	Payback	STTP*	X	X	X	X	X	X
	Universal Curved Front bin/shelf	STUC*	X	X	X	X	X	X
	Universal	STUV*	X	X	X	X	X	X
<b>Tayco</b>	Ideaz	TAIZ	X	X	X	X	X	X
<b>Teknion</b>	Boulevard	TKBV*	X	X	X	X	X	
	Boulevard - deep shelf*	TKBD*	X	X	X	X	X	X
	Chronicle	TKCH	X	X	X	X	X	X
	Expansion	TKEXP	X	X	X	X	X	X
	Leverage	TKLV*	X	X	X	X	X	X
	TOS	TKTOS	X	X	X	X	X	X
	TOS - deep shelf	TKTOD	X	X	X	X	X	
	Transit	TKTR	X	X	X	X	X	X
<b>Wood or Laminate shelf</b>	WS		X	X	X	X	X	

Light Corporation's task lights are currently compatible with the systems listed above. If a manufacturer or system is not listed here, contact Light Corporation for availability.

### Important mounting notes:

System codes marked with "\*" - specify a task light that is 6" shorter than the shelf / overhead that it will be mounted in. For example, a 30" shelf would require an MT5 24 or shorter or a VT24 or shorter.

System codes marked with "\*\*\*" - for a 60" shelf an MT5 60 will not fit. A VT58 must be specified for that application.

# Panel measurement guide

Use this guide to determine what size mounting brackets are needed to mount personal task light or ambient lights to a furniture panel. Use when the manufacturer and / or system name panel is not known or if system is not listed on page 58. This page may be copied and faxed in with your purchase order. A Customer Service Representative will contact you on availability.

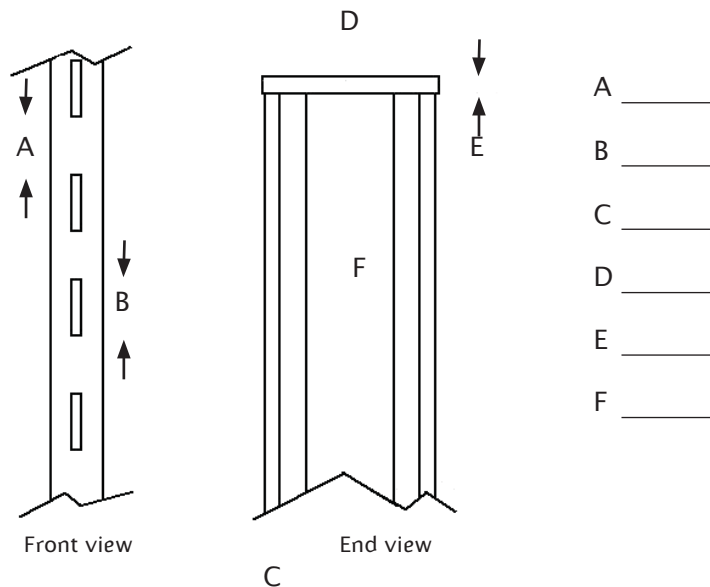

- A \_\_\_\_\_
- B \_\_\_\_\_
- C \_\_\_\_\_
- D \_\_\_\_\_
- E \_\_\_\_\_
- F \_\_\_\_\_

### For mounting in the slotted standards:

- On the metal standard, measure distances A and B.
- Looking at the end of the panel, measure dimension C. This is the width of the panel skin.

### For mounting to the top of a panel:

- Measure the width of top cap, dimension D.
- Measure the height of the top cap, dimension E.
- Measure the width of the panel, dimension F.

# Shelf measurement guide

Use this guide to determine what size mounting brackets are needed to mount the task light you have specified. Use when the manufacturer and / or system name of overhead storage unit (binder) is not known or if system is not listed on page 50. This page may be copied and faxed in with your purchase order. A Customer Service Representative will contact you on availability.

## Step 1: Determine the depth of the unit

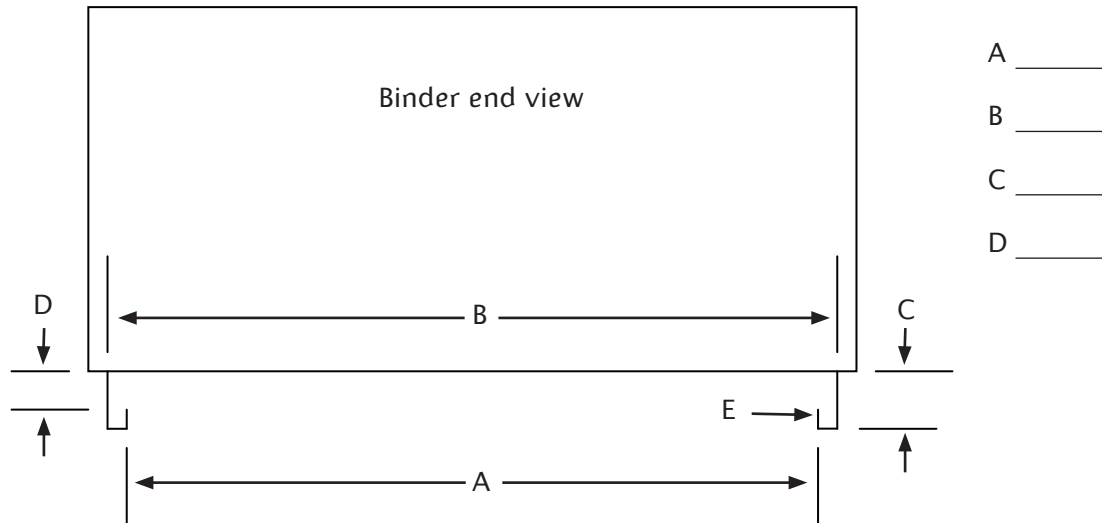

1. Measure distances between points A, B, and C.
2. If a vertical extension E is present, measure distance D.
3. If there are any obstructions within spacing C that could in anyway affect proper mounting of task light, list them here.

---



---

4. If dimensions C and D are NOT consistent at both the front and rear of the unit, explain differences here.

---



---

## Step 2: Determine the width of the unit

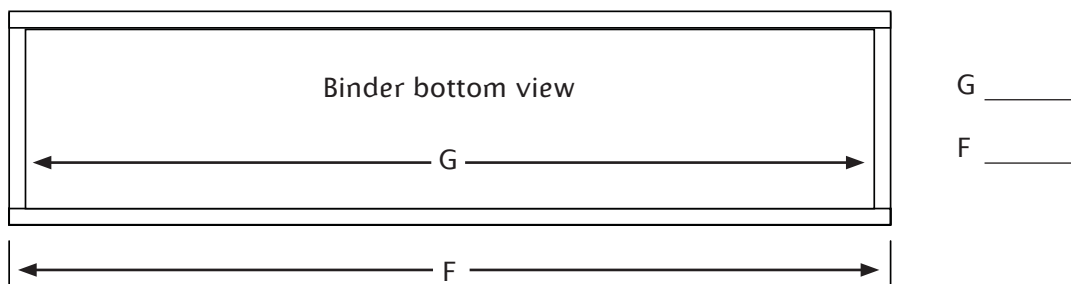

1. Measure distances between points G and F.
2. If there is anything in mounting space G that might in anyway interfere with or prevent proper mounting of the task light, list here. I.e. hat channel, side returns, etc. If possible, include digital picture, spec sheets, or sketches.

---



---

## Step 3: Supply additional information if available

1. What type of measuring device was used: Tape measure Ruler Calipers
2. Who is the manufacturer of the overhead storage unit: \_\_\_\_\_
3. What is the system name: \_\_\_\_\_
4. Who is your local Sales Representative: \_\_\_\_\_

# Glossary of terms

**Ambient lighting:** Lighting throughout an area that provides general illuminations.

**Ballast:** A device used with an electric-discharge lamp to obtain the necessary circuit conditions (voltage, current, and wave form) for starting and operating.

**Batwing distribution:** A symmetrical light distribution producing light pattern angles to the right and left of the observer with comparatively little direct downward illumination. The shape is thus similar to that of a batwing.

**Batwing lens (linear prismatic):** A lens, usually of molded or extruded acrylic, consisting of a series of prisms that cause a batwing distribution of light.

**Candela:** The unit of measure indicating the luminous intensity (candle power) of a light source in a specific direction; any given light source will have many different intensities, depending upon the direction considered.

**Color rendering index (CRI):** A method for describing the effect of a light source on the color appearance of objects being illuminated, with a CRI of 100 representing the reference condition (and thus the maximum CRI possible). In general, a lower CRI indicates that some colors may appear unnatural when illuminated by the lamp.

**Color temperature (chromaticity):** The degree of warmth or coolness of a light source, measured in degrees Kelvin (K). The higher the degree K, the more blue, or cooler the lamp appears. The lower the degree K, the more red, or warmer the lamp appears.

**Contrast:** The difference between the luminance (brightness) of the detail in a visual task and the luminance of its immediate background (e.g., between the print and the paper).

**Correlated color temperature (CCT):** A description of the color appearance of a light source in terms of its warmth or coolness. The CCT relates the color appearance of the light emitted by the lamp to the color appearance of the reference material heated to a high temperature (measured on the Kelvin scale, abbreviated K). As the temperature rises, the color appearance shifts from yellow to blue. Thus, lamps with a low CCT (3000 degrees K or less) have a yellow-white color appearance and are described as “warm”; lamps with a high CCT (4000 degrees K or higher) have a blue-white color appearance and are described as “cool”.

**Diffuser:** A device to redirect or scatter the light from a source, primarily by the process of diffuse transmission.

**Direct glare:** Glare resulting from the excessive brightness or insufficiently shielded light sources in the field of view.

**Electric-discharge lamp:** A lamp in which light is produced by passing an electric current through a gas. These lamps may be named after the gas they contain, as in mercury lamps, sodium lamps, neon lamps; or they may be named for their operating parameters or dimensions, as in short arc lamps, high pressure lamps, etc.

**Fluorescent lamp:** A low pressure mercury, electric-discharge lamp in which phosphor coating transforms ultraviolet energy (created by electric discharge) into visible light.

**Fixture:** A complete lighting unit consisting of a lamp or lamps together with parts designed to distribute the light, to position and protect the lamps, and to connect the lamps to the power supply. Also called Luminaire.

**Footcandle (fc):** A unit of measurement indicating how much illumination is reaching a surface. It is equal to one lumen striking an area of one square foot.

**General lighting:** Lighting designed to provide a substantially uniform level of illumination throughout an area, exclusive of any provision for special local requirements.

**Glare:** A sensation caused by light within the visual field that is brighter than the level of light to which the eyes are adapted, causing annoyance, discomfort or loss in visual performance.

**Halogen Lamps:** High pressure tungsten filament lamps containing halogen gases. The halogen gases allow the filaments to operate at higher efficacies than incandescent lamps.

**High-Intensity Discharge (HID) lamps:** Lamps in which an arc passing between two electrodes in a pressurized tube causes various metallic additives to vaporize and release large amounts of light.

**Illuminance:** The amount of light that reaches a surface. Illuminance is measured in footcandles (lumens/square foot) or lux (lumens/square meter). One footcandle equals 10.76 lux, although for convenience the IESNA uses 10 lux as the equivalent.

# Glossary of terms

**Electric-discharge lamp:** A lamp in which light is produced by passing an electric current through a gas. These lamps may be named after the gas they contain, as in mercury lamps, sodium lamps, neon lamps; or they may be named for their operating parameters or dimensions, as in short arc lamps, high pressure lamps, etc.

**Encapsulation:** A hard rugged epoxy surrounding the LED die, provides diffusion & lensing of the LED light.

**Energy:** A measure of work done by an electrical system over a given period of time, often expressed in kilowatt-hours (kWh).

**Fluorescent lamp:** A low pressure mercury, electric-discharge lamp in which phosphor coating transforms ultraviolet energy (created by electric discharge) into visible light.

**Fixture:** A complete lighting unit consisting of a lamp or lamps together with parts designed to distribute the light, to position and protect the lamps, and to connect the lamps to the power supply. Also called Luminaire.

**Foot candle (fc):** A unit of measurement indicating how much illumination is reaching a surface. It is equal to one lumen striking an area of one square foot.

**Forward current:** Current through a diode in the direction of its greatest conduction.

**Forward voltage (Vf):** The operating voltage of the LED. The typical rating is the voltage at which the LED will light. The maximum rating is the voltage that, if exceeded, will diminish LED lifetime.

**General lighting:** Lighting designed to provide a substantially uniform level of illumination throughout an area, exclusive of any provision for special local requirements.

**Glare:** A sensation caused by light within the visual field that is brighter than the level of light to which the eyes are adapted, causing annoyance, discomfort or loss in visual performance.

**Halogen Lamps:** High pressure tungsten filament lamps containing halogen gases. The halogen gases allow the filaments to operate at higher efficacies than incandescent lamps.

**High-Intensity Discharge (HID) lamps:** Lamps in which an arc passing between two electrodes in a pressurized tube causes various metallic additives to vaporize and release large amounts of light.

**Illuminance:** The amount of light that reaches a surface. Illuminance is measured in footcandles (lumens/square foot) or lux (lumens/square meter). One footcandle equals 10.76 lux, although for convenience the IESNA uses 10 lux as the equivalent. Indirect lighting: Lighting by luminaires distributing 90 to 100 percent of the emitted light upward.

**Instant-start:** A method of starting fluorescent lamps in which the voltage that is applied across the electrodes to strike the electric arc is up to twice as high as it is with other starting methods. The higher voltage is necessary because the electrodes are not heated prior to starting. This method starts the lamps without flashing; it is more energy efficient than rapid or preheat starting, but results in greater wear on the electrodes during starting. The life of instant-start lamps that are switched on and off frequently may be reduced by as much as 25 percent relative to rapid-start operation. However, for longer burning cycles (such as 12 hours per start), there may be no difference in lamp life for different starting methods.

**Lamp:** A generic term for a man-made source of light.

**Lamp flicker:** Cyclic variation in output of a light source. High frequency electronic ballasts provide a minimal level of lamp flicker.

**Lamp Lumen depreciation Factor (LLDF):** The multiplier to be used in illumination calculations to relate the initial rated output of light sources to the anticipated minimum rated output based on the relamping program.

**LED power supply:** An electronically stabilized power supply that converts AC line voltage to DC constant voltage or DC constant current drive for the LED modules. DC LED power supplies convert DC voltage from a battery source or another power supply to the appropriate current or voltage drive for the LED module.

**Lens:** A glass or plastic shield that covers the bottom of a luminaire to control the direction and brightness of the light it emits.

**Light:** Radiant energy that is capable of exciting the retina and producing a visual sensation.

**Light-emitting diode (LED):** A solid-state semiconductor device that converts electrical energy directly into light.

# Glossary of terms

**Louver:** A series of baffles used to shield a light source from view at certain angles or to absorb unwanted light. The baffles are usually arranged in a geometric pattern.

**Lumen:** The unit of measurement defining the output of a lamp. Could be said to measure a volume of light.

**Lumen depreciation:** The decrease in lumen output of a light source over time; every lamp type has a unique lumen depreciation curve. (Sometimes called Lumen maintenance curve)

**Luminous efficacy:** The most commonly used measure of the energy efficiency of a light source. It is stated in lumens per watt (lm/W), indicating the amount of light a light source produces for each watt of electricity consumed. For white high-brightness LEDs, luminous efficacy published by LED manufacturers typically refers to the LED chip only, and doesn't include driver losses.

**Luminaire:** A light fixture; the complete lighting unit. In LED light fixtures, this includes the LED light source, power supply, wiring, diffuser, and housing.

**Luminaire efficiency:** The ratio of the light emitted by a luminaire to the light emitted by the lamp or lamps within it. Components of a luminaire such as reflectors and diffusers absorb some of the light from the lamp(s). A highly efficient luminaire emits most of the light that the lamp(s) emits.

**Luminance:** Light reflected in a particular direction; the photometric quantity most closely associated with brightness perception, measured in units of luminous intensity (candelas) per unit area (square feet or square meters).

**Luminance contrast:** The relationship between the luminances of an object and its immediate background.

**Luminance ratio:** The ratio between the luminances of any two areas in the visual field.

**Luminous flux:** The time rate of flow of light. Luminous flux is defined as the total electromagnetic energy emitted by the light source into a sphere surrounding the light source.

**Luminous intensity (Iv):** Luminous intensity is equal to the amount of luminous flux emitted into a very small solid angle at a defined angular orientation from the light source. The measurement for luminous intensity is the lumen or candela.

**Lux (Ix):** A unit of illuminance. One lux is one lumen per square meter.

**Matte surface:** A surface from which the reflection is predominately diffuse, with or without a negligible specular component.

**Mean lumens:** Lumen output of a light source after the source has been used.

**Mean spherical candle power (MSCP):** The average luminous intensity of a lamp illuminating in all directions. The measurement is made by placing the lamp in the center of a sphere.

**Offending zone:** A lighting location that produces maximum veiling reflections.

**Open plan office:** An office space, divided by screened or panels that do not reach the ceiling, with desk layouts designed through a system planning process to produce a flexible office environment.

**Operating current:** The amount of current an LED is designed to draw from the power source.

**Operating temperature:** The temperature range over which an LED is designed to operate safely.

**Portable lighting:** Lighting from a fixture designed for manually portability.

**Power factor:** A measure of how effectively a ballast converts current and voltage into usable power to operate the lamps. A power factor of 0.9 or greater indicates a high power factor ballast.

**Preheat:** A method of starting fluorescent lamps in which the electrodes are heated before a switch opens to allow a starting voltage to be applied across the lamp. With preheat starting, the lamp flashes on and off for a few seconds before staying lit, because several starting attempts may be necessary to establish the electric arc across the lamp electrodes. Often, the luminaire's start button must be held down until the lamp lights. Preheat ballasts are less energy efficient than rapid-start or instant-start ballasts.

**Prismatic lens:** An optical component of a luminaire that is used to distribute the emitted light. It is usually a sheet of plastic with a pattern of pyramid-shaped refracting prisms on one side. Most ceiling-mounted luminaires in commercial buildings use prismatic lenses.

# Glossary of terms

**Printed circuit board:** Insulating board containing conductive tracks for the circuit connections.

**Quality of lighting:** Pertains to the distribution of luminance in a visual environment. The term is used in a positive sense and implies that all luminances contribute favorably to visual performance, visual comfort, ease of seeing, safety, and aesthetics for the specific visual tasks involved.

**Rapid-start:** A method of starting fluorescent lamps in which the ballast supplies voltage to heat the lamp electrodes for 1 to 2 seconds prior to starting and, in most cases, during lamp operation. A rapid-start system starts smoothly, without flashing.

**Reflected glare:** Glare resulting from specular reflections of high luminances in polished or glossy surfaces in the field of view. It usually is associated with reflections from within a visual task or areas in close proximity to the region being viewed.

**Reflection:** A general term for the process by which the incident flux leaves a surface or medium from the incident side, without change in frequency.

**Reflector:** A device used to redirect the luminous flux from a source by the process of reflection.

**Solid-state lighting (SSL):** Technology that uses semi-conducting materials to convert electricity into light. SSL is an umbrella term encompassing both light-emitting diodes (LEDs) and organic light emitting diodes (OLEDs).

**Storage temperature:** The temperature range over which an LED is designed to be stored safely in the off-state.

**Surface mount (SMT) LED:** SMT LEDs are soldered to the surface of the circuit board. The LED die is integrated into the package design. SMT components can be assembled faster and with better quality than through-hole components.

**Task lighting:** Lighting directed to a specific surface or area that provides illumination for visual tasks.

**Task-ambient lighting:** A combination of task lighting and ambient lighting within an area such that the general level of ambient lighting is lower than and complementary to the task lighting.

**Through-hole LED:** This kind of package is soldered "through holes" to the circuit board. The LED chip is seated in a reflector and light is emitted by a lens integrated into the package. Different radiation characteristics are produced as a function of chip-to-lens spacing and the shape of the lens.

**Total harmonic distortion (THD):** A measure of the degree to which a sinusoidal wave shape is distorted by harmonic wave forms, with higher values of THD indicating greater distortion. Electrical devices, such as computers and fluorescent lighting systems, can send harmonic wave forms at many frequencies back onto the power supply line, thereby distorting the current wave shape. For 4-foot lamps, the American National Standards Institute (ANSI) recommends a THD limit of 32 percent, but some electric utilities only provide financial incentives for ballasts that produce less than 20 percent THD. Ballasts that produce less than 10 percent THD are available for installations with critical power requirements.

**Veiling luminance:** A luminance superimposed on the retinal image which reduces its contrast. It is the veiling effect produced by bright sources or areas in the visual field that results in decreased visual performance and visibility.

**Veiling reflection:** A reflection of a light source that obscures task details by reducing the contrast between them and their background. Also known as reflected glare.

**Viewing angle:** Viewing angle is the total cone angle in degrees encompassing the central, high luminous intensity portion of the LED beam from the on-axis peak to the off-axis point where the LED intensity is 50% of the on-axis intensity. This off-axis point is known as theta one-half ( $\theta_{1/2}$ ). Two times  $\theta_{1/2}$  is the LEDs' full viewing angle; however, light is visible beyond the  $\theta_{1/2}$  point.

**Visual performance:** The quantitative assessment of the performance of the visual task, taking into consideration speed and accuracy.

**Visual task:** Conventionally designates those details and objects that must be seen for the performance of a given activity and includes the immediate background of the details or objects.

**Waterclear encapsulation:** An LED lens without tint or color. The LED color cannot be determined in the off state.

**Watt:** A unit of electrical power equal to 1 joule per second. Lamps are rated in watts to indicate power consumption.

# Terms and conditions

1. Special Item Numbers: SIN # 722-01 Fluorescent Lighting Fixtures
2. Maximum Order Limitation: \$100,000 (All SIN numbers)
3. Minimum Order Limitation: \$54.12
4. Geographic Coverage: Covers the forty eight (48) contiguous states of the United States including the District of Columbia; delivery will be made to port of embarkation to Alaska, Puerto Rico, and Hawaii.
5. Point of Production: Grand Haven, MI
6. Discount: Prices are shown Net Government Price (discounts already deducted)
7. Quantity Discount: Additional 2% discount for purchases at \$50,000-\$100,000.
8. Payment Terms: Net 30 days, 1-1/2% interest per month will be added to past due accounts.
9. Government Credit Card: Accepted. No cash discounts on credit card purchase.
10. Terms and Conditions of Credit Card: At or below the micro-purchase threshold.
11. Foreign Terms: N/A
12. Time of Delivery: 14-60 Days after receipt of order
13. Expedited Delivery: All items available for expedited delivery. Overnight & 2nd day delivery available upon request. For urgent requirements, please contact Light Corporation Customer Service.
14. F.O.B. Point: F.O.B. Destination
15. Ordering Address: Light Corporation  
14800 172nd Avenue  
Grand Haven, MI 49417  
Phone: 800-544-4899  
Fax: 616-846-2144
16. Payment Address: Light Corporation  
21998 Network Place  
Chicago, IL 60673-1219
17. Export Packing Charges: Quoted upon request
18. Rental Terms: N/A
19. Installation Terms: N/A
20. Cancellation: Cancellation of special orders will not be accepted after 24 hours from order entry.
21. Warranty: Light Corporation offers a 12 year warranty on all task lights, excluding lamps and ballasts. Electronic ballasts are warranted for a period of five years. Personal task lights are warranted for a period of five years excluding lamps and ballasts.  
  
Products are warranted to be free from defects in material and workmanship, from the date of invoice, when used in standard conditions. During the warranty period, Light's obligation is limited to the repair and or replacement, at its option, of the products. This warranty does not apply to damage resulting from storage, alteration or misuse of the product. Light Corporation has no obligation for consequential or incidental damages. Light Corporation (consignor) will be responsible for filing claims with carrier for freight damage. There are no implied warranties of merchantability or fitness for a particular purpose.  
  
All LED lighting fixtures, which include the Trillium TLED and the Reed SRD task light are warranted for a period of 3 years from date of manufacture. The LED power supply for all LED lighting elements is warranted for a period of 1 year. Note that the LED products are not field serviceable if a defect occurs to an LED product during its warranty period and upon approval from a Light Corporation representative, the product must be returned for repair or replacement.
22. Returned Goods: Product returned to Light Corporation in Grand Haven, Michigan, must be accompanied by an RGA number, which is issued by the Customer Service Department. Any product returned without such authorization will be returned to sender, unopened, and at the original buyers expense. A restocking charge of 20% will be applied to returns which Light has not erred in shipping.
23. Environmental Attributes: Energy efficient products  
Ecologic lamps (low mercury) in the VT product line  
ISO-14001  
Use of occupancy sensors and dimmers in task lights
24. List of Dealers: Please contact Light Corporation for the name of your nearest authorized dealer.
25. Fed ID: 38-2696632  
DUNS: #17-829-6976
26. Central Contact Registration (CCR) Database: Light Corporation is registered.  
[www.lightcorp.com](http://www.lightcorp.com)

